

| | |
|-------------|----------------------------|
| Basic | .STAL8VF_2e |
| | .STAB-AC -VVVF-Closed Loop |
| | Rev.: 2 |
| PAGE 2 / 11 | |

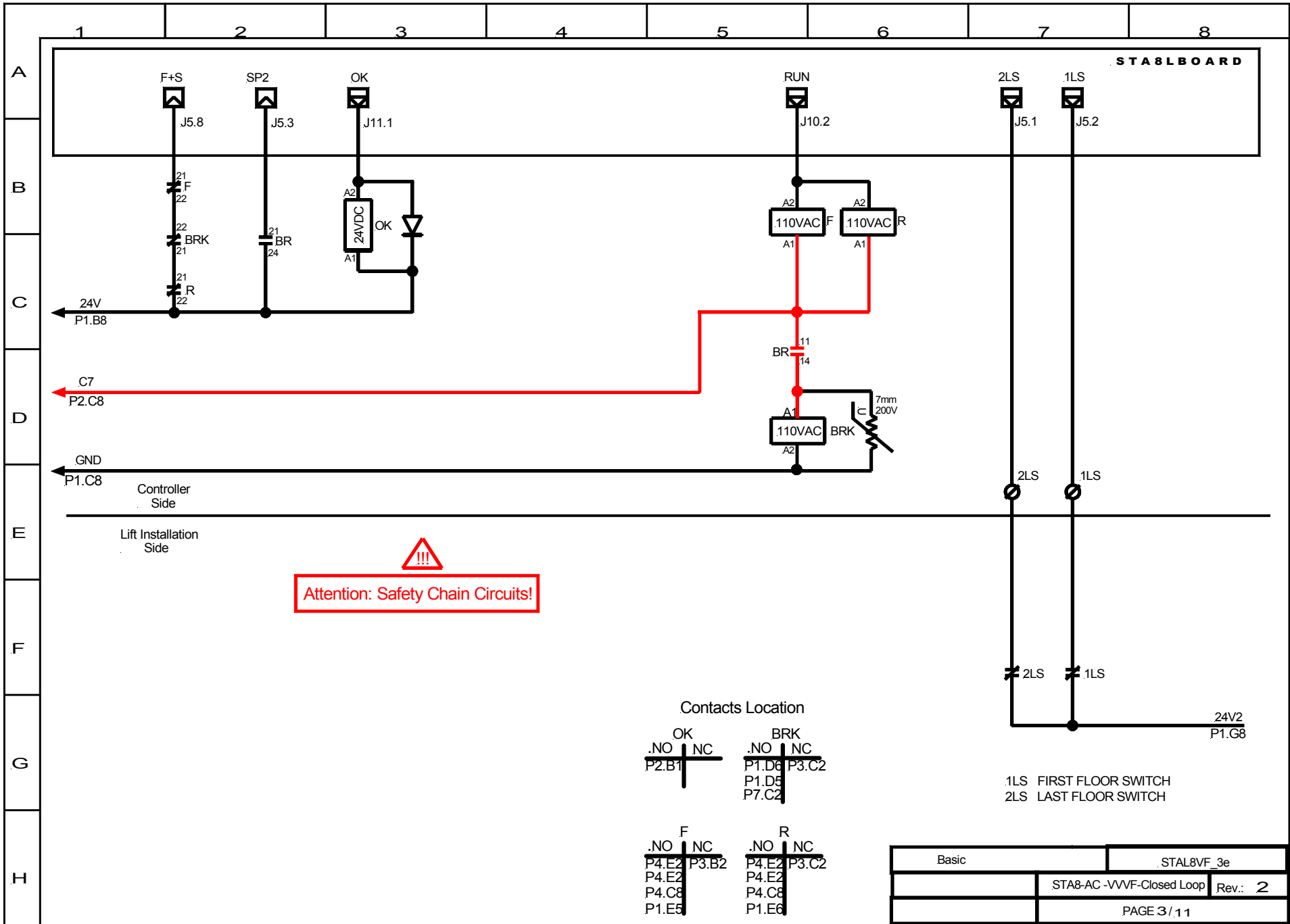

!!!
 Attention: Safety Chain Circuits!

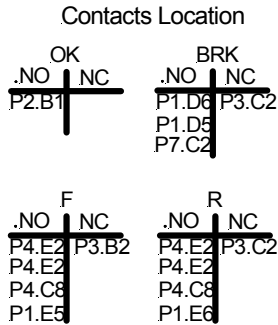

1LS FIRST FLOOR SWITCH
2LS LAST FLOOR SWITCH

| | |
|-------------|-----------------------------------|
| Basic | STAL8VF_3e |
| | STA8-AC -VVVF-Closed Loop Rev.: 2 |
| PAGE 3 / 11 | |

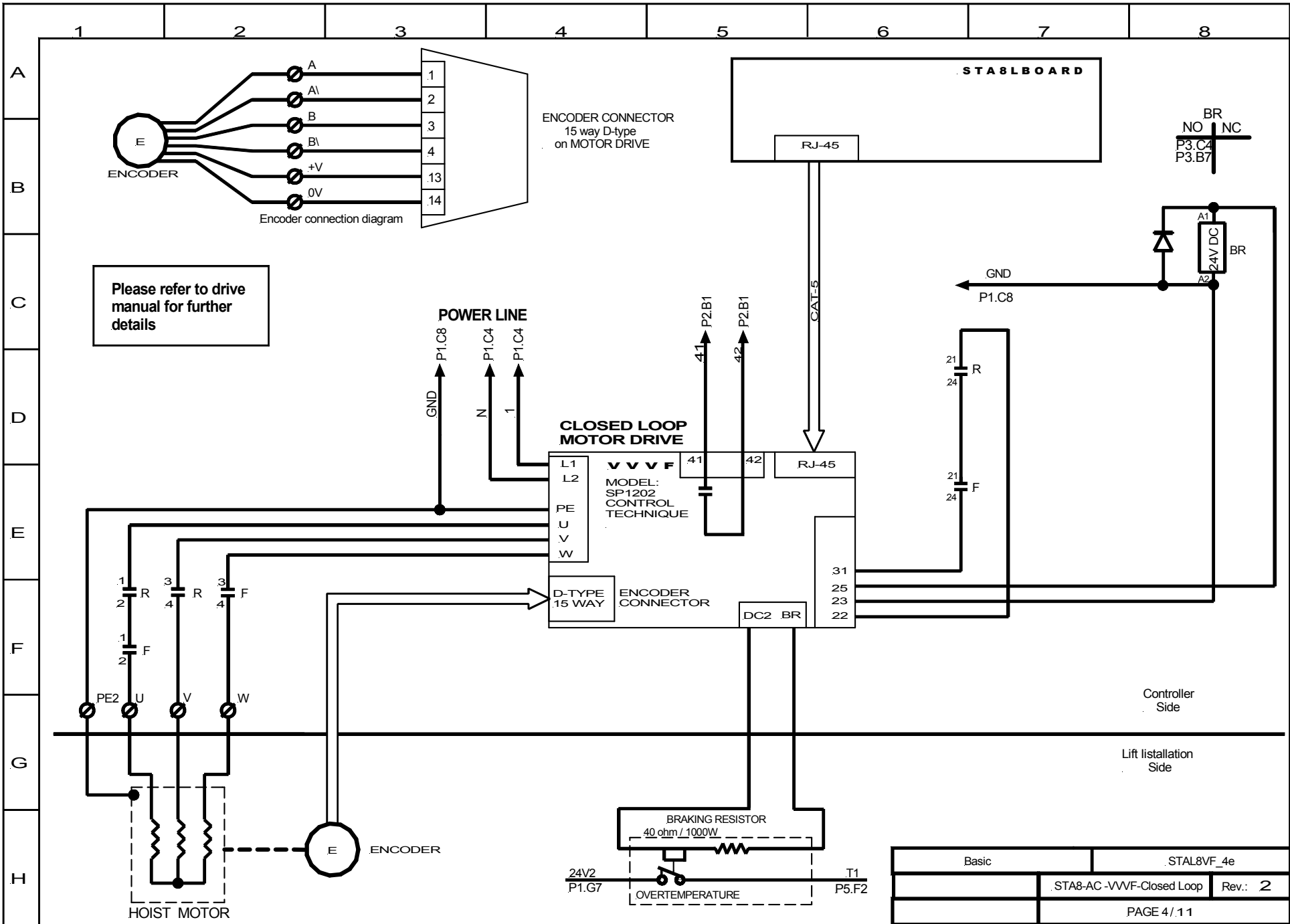

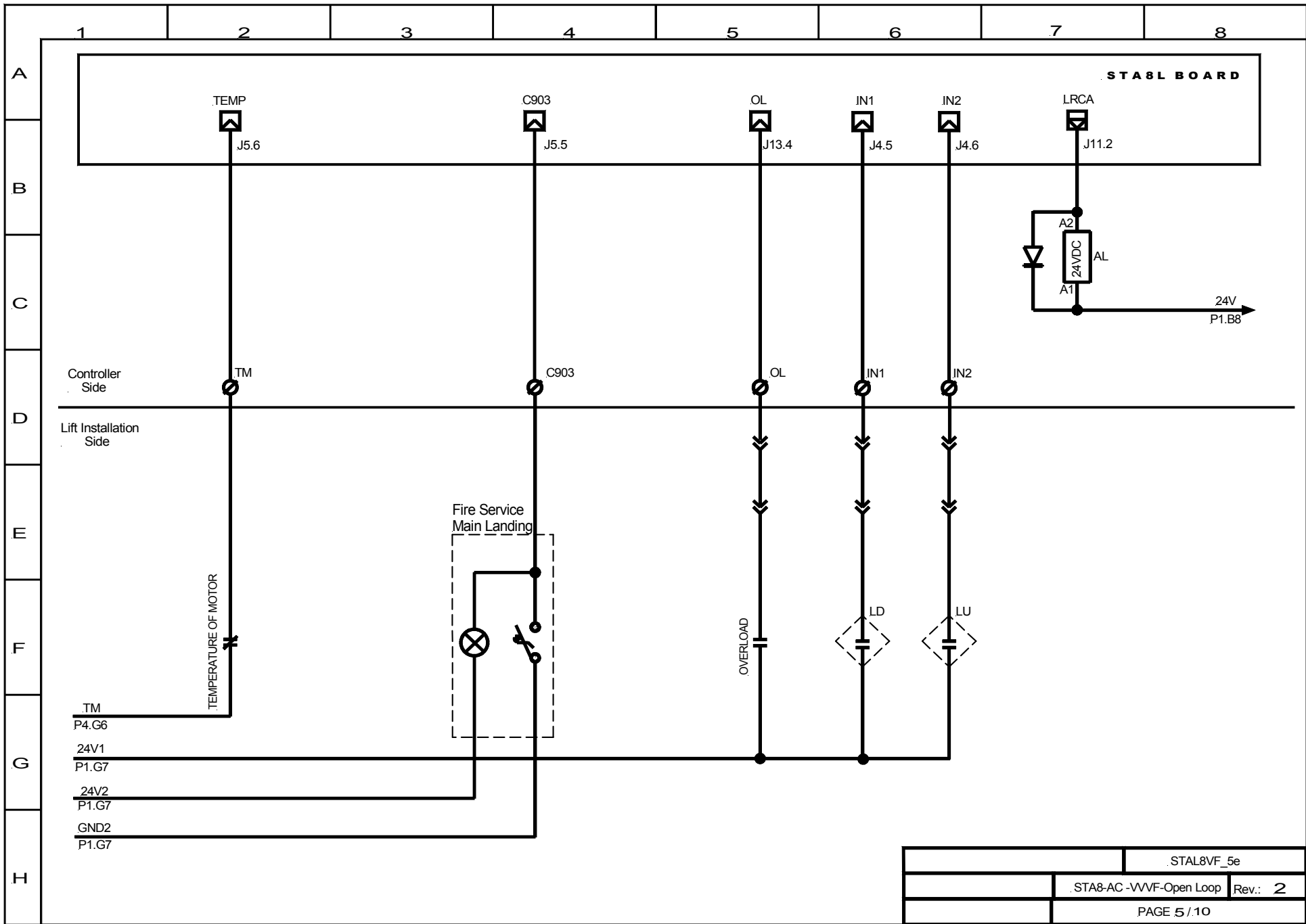

| | | |
|--|--|----------------------------------|
| | | .STAL8VF_5e |
| | | .STA8-AC -VVVF-Open Loop Rev.: 2 |
| | | PAGE 5 / 10 |

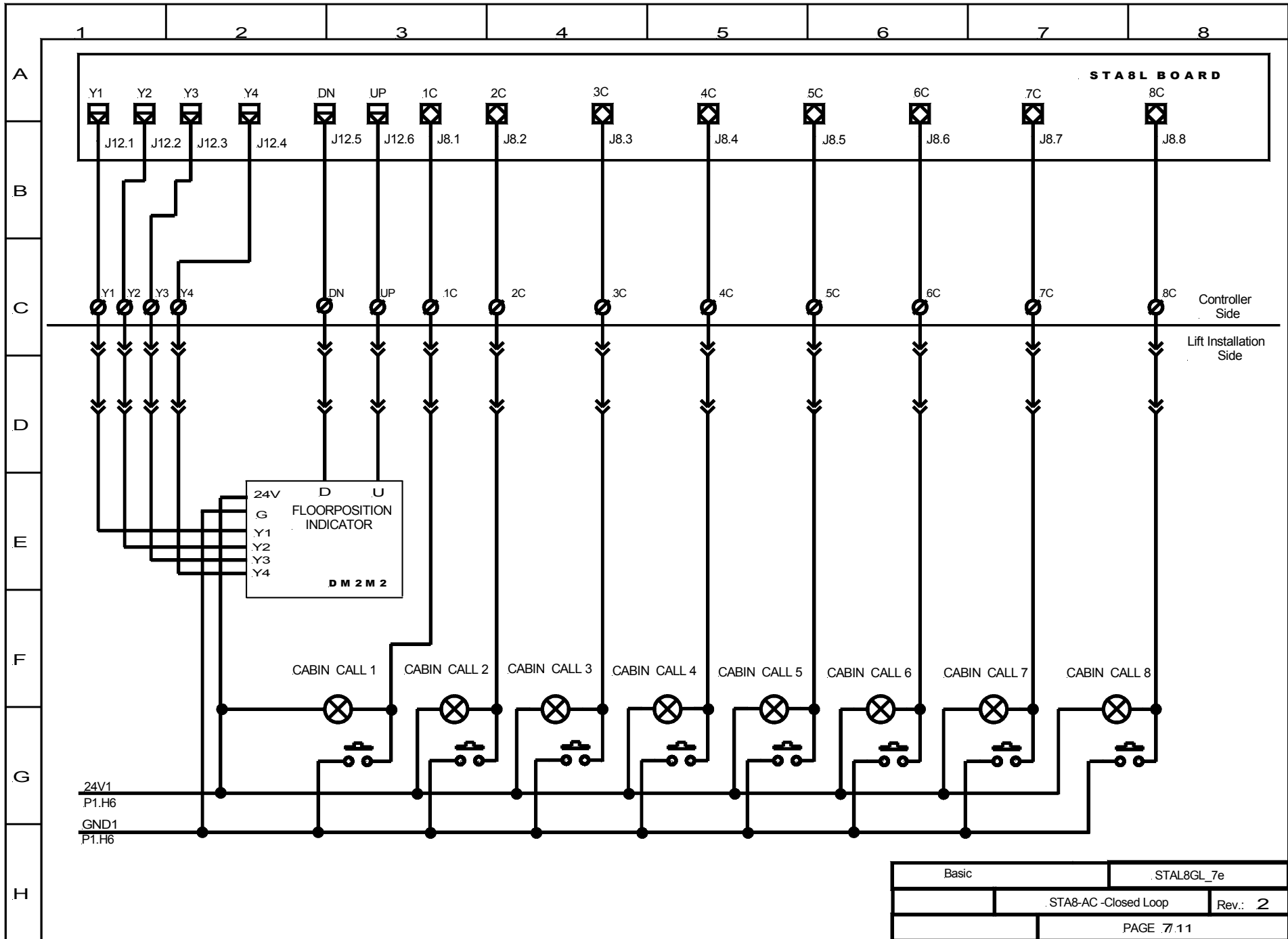







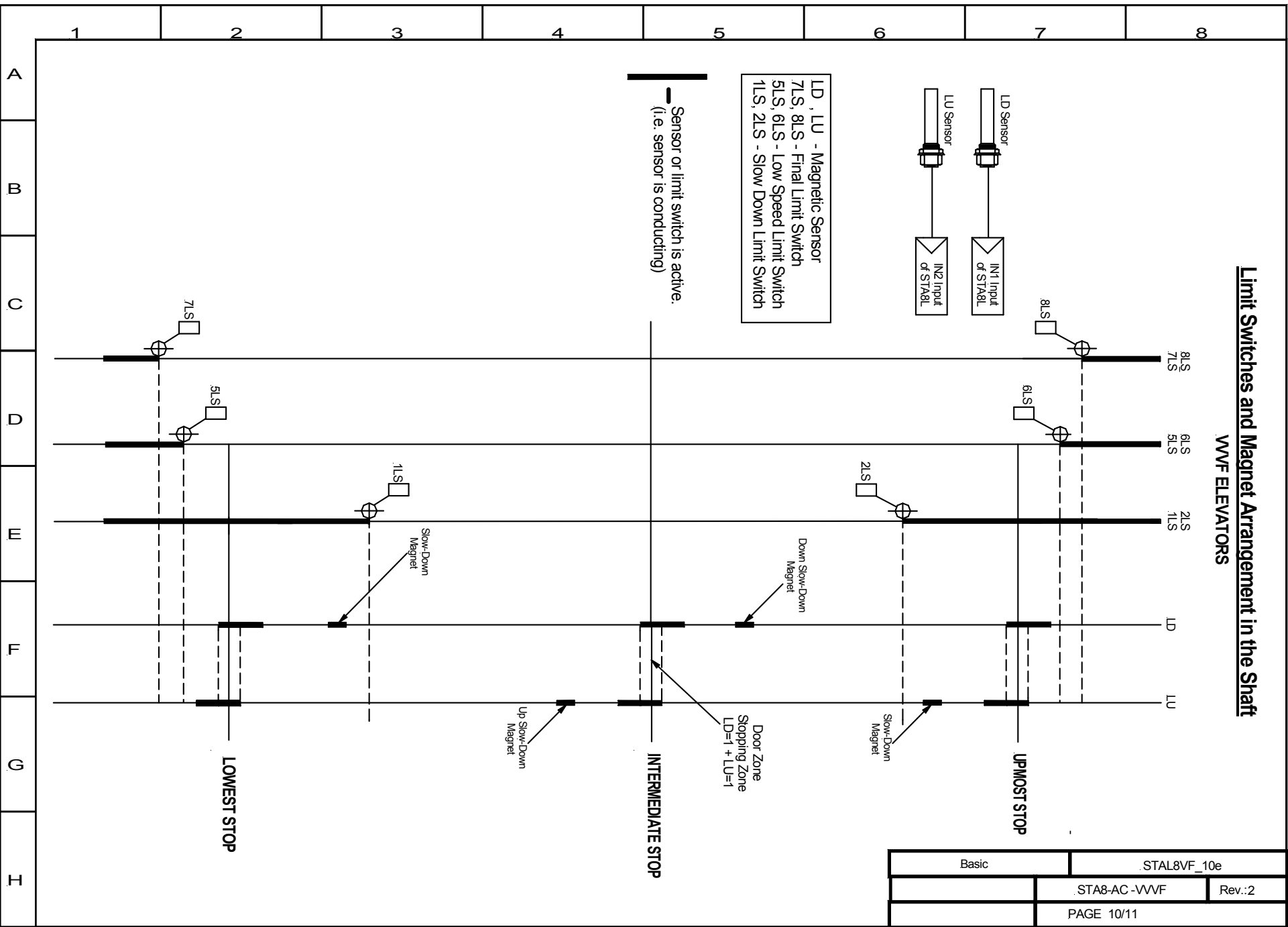











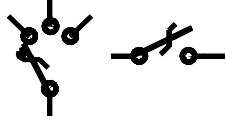

| | | |
|-----------|-----------------------|---------|
| Basic | .STAL8GL_7e | |
| | .STA8-AC -Closed Loop | Rev.: 2 |
| PAGE 7.11 | | |

Limit Switches and Magnet Arrangement in the Shaft

VVVF ELEVATORS



| | | |
|-------|--------------|--------|
| Basic | STAL8VF_10e | |
| | STA8-AC-VVVF | Rev.:2 |
| | PAGE 10/11 | |

| | 1 | 2 | 3 | 4 | 5 | 6 | 7 | 8 |
|---|---|---|--|---|---|---|---|-----------------------|
| A | | P1.G7 - PAGE ONE, AREA G7 | | | | |  | TOGGLE SWITCH |
| B | |  | . TERMINAL BLOCK OF CONTROL PANEL | | | |  | . EMERGENCY SWITCH |
| C | |  | . TRAVELING CABLE | | | |  | N.C. PRESSURE SWITCH |
| D | |  | CONTROL BOARD POWER TERMINAL | | | |  | PUSHBUTTON |
| D | |  | CONTROL BOARD INPUT | | | |  | KEYSWITCH |
| E | |  | CONTROL BOARD OUTPUT | | | |  | N.C. LIMIT SWITCH |
| F | |  | CONTROL BOARD TERMINAL, INPUT / OUTPUT | | | |  | VARISTOR |
| F | |  | RELAY COIL | | | |  | CONTROLLER'S TERMINAL |
| G | |  | CONTACTOR COIL | | | |  | MAGNETIC SENSOR |
| H | |  | N.O. CONTACT | | | |  | ELECTRIC VALVE |
| H | |  | N.C. CONTACT | | | | | |

| | | |
|-------|---------------|---------|
| Basic | . STAL8VF_11e | |
| | STA8-AC-VVVF | Rev.: 2 |
| | PAGE .11 / 11 | |